



AIR BARRIERS

# ENERSHIELD

ENERGY SAVING BARRIERS

CREATES UP TO A 90% SEAL ON OPEN DOORS USING FACILITY AIR



AIR BARRIERS

## Microshield MCS-36-DW - Air Barrier Specifications

Enershield Air Barriers create an effective seal on the doorway. This is achieved by re-circulating the facility air in a laminar (smooth) flow across an open doorway. In addition, the kinetic energy within the moving air generates a barrier preventing leakage of air between two areas with different pressure and climate.

Microshield Air Barriers are ideal for most foot traffic doorways up to 8' high. They are aesthetic, efficient and extremely quiet during operation. Microshields are ideal for areas with low head room above the doorway. Applications include retail doorways, employee entrances and exits, patio doors, foot traffic receiving doors, food preparation and refrigerated areas.

**Features:** Manual control, painted full length articulating discharge nozzle, full length painted steel rear mounting bracket, with decorative top intake grilles and side panels, 7.5' 110V grounded power cord, accessory extension mounting brackets included

MCS-36-DW		
	Metric	Imperial
Cabinet Length	902 mm	36"
Width x Height	210 x 235 mm	8.25 x 9.25"
Weight	16 kg	36.2 lbs
Number of Motors	2	
Voltage	110/120 V, Single Phase, 60 Hz	
Total Current FLA	3.5 A	
Total Power	1 Motor @30W / 1 Motor @ 60W	
Noise @ 2m	52 dB	
Air Velocity at Outlet	16 m/s	3,150 fpm
Total Air Volume	0.31 m <sup>3</sup> /s	647 cfm
Installation Height	2.4 m Maximum	8' Maximum



WWW.ENERSHIELD.COM

EMAIL: ENQUIRIES@ENERSHIELD.COM



**THINK ENERGY, THINK ENVIRONMENT, THINK ENERSHIELD.**

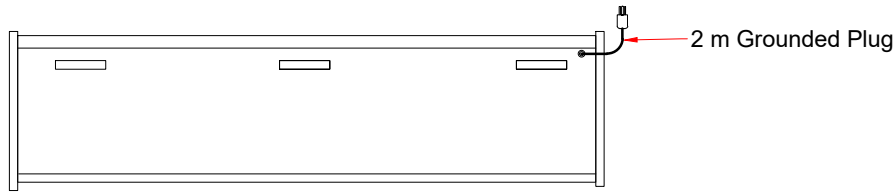

BACK VIEW

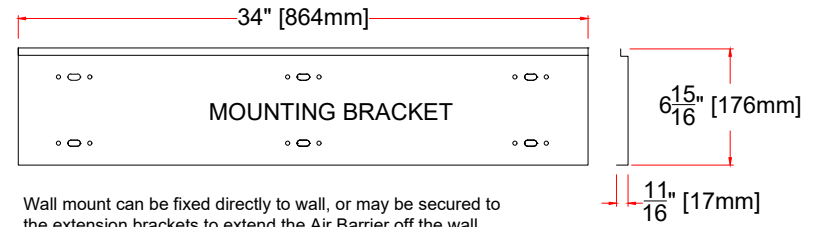

Wall mount can be fixed directly to wall, or may be secured to the extension brackets to extend the Air Barrier off the wall.

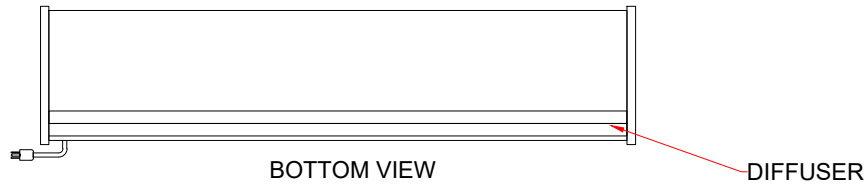

BOTTOM VIEW

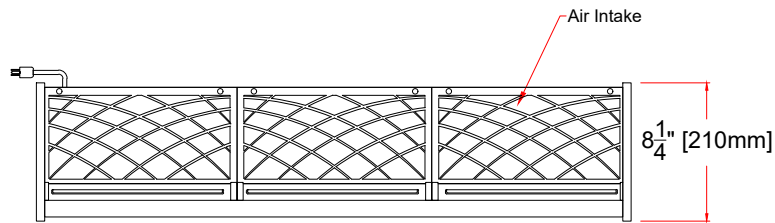
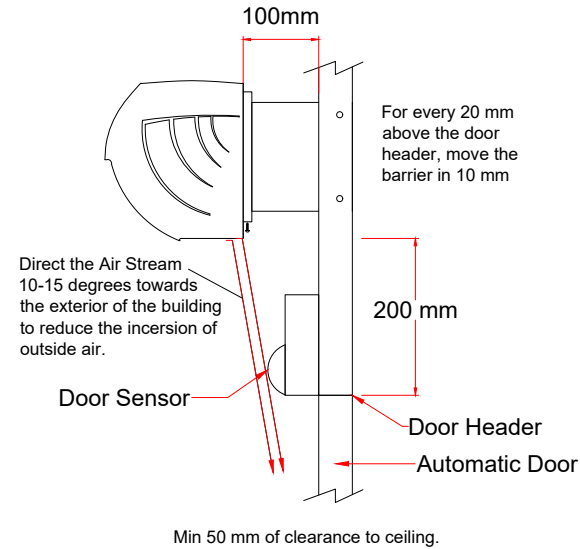

TOP VIEW

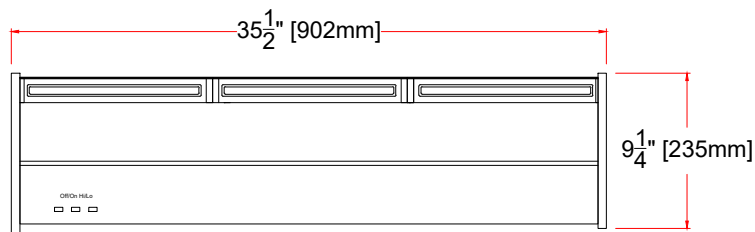
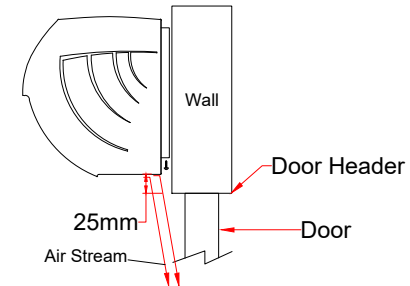

FRONT VIEW

UKCA, CSA + CE Certified

ENERSHIELD CANADA

95 Albert Street S.

Sunderland, ON L0C 1H0

Tel: 1-855-272-1272

E-mail: [enquiries@enershield.com](mailto:enquiries@enershield.com)

Website: [www.enershield.com](http://www.enershield.com)



MICROSHIELD AIR BARRIER  
AVAILABLE IN WHITE, BLACK AND ALUMINUM FINISH

Voltage	110 / 120V Single Phase 60Hz
Motor (s)	1 @ 60W, 1 @ 30W
Amps FLA	2.7
	2 Speed Motors TEAO

MICROSHIELD

MCS-36-DW

Air Velocity (fpm) (m/s)	3150 / 16
Air Volume (cfm) (m³/s)	647 / 0.31
Total Power (hp) (kW)	1@30 / 1@60
Weight (lbs) (Kg)	36.2 / 16